

General Specifications

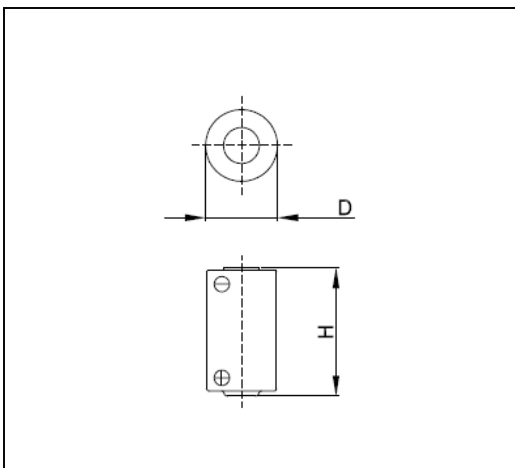

Nominal Voltage (V)		3
Nominal Capacity (mAh) *1		920
Standard Discharge Current (mA)		0.5
Operating Temperature Range (°C) *2		-40 ~ +85
Max. Dimensions (mm)	Diameter (D)	14.5
	Height (H)	25.0
Approx. Weight (g)		9

*1 Nominal capacity is determined at an end voltage of 2.0V when the battery is allowed to discharge at a standard current level at +23°C.

*2 Consult FDK when using batteries at temperatures exceeding the -20°C to +60°C range.

Note) Battery Handling Precautions

English) http://www.fdk.com/battery/lithium_e/caution/

Japanese) <http://www.fdk.co.jp/battery/lithium/caution/>

Typical Characteristics

Temperature Discharge Characteristics

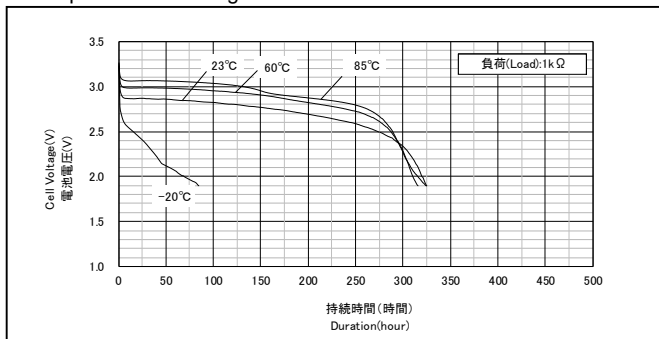

Temperature Discharge Characteristics

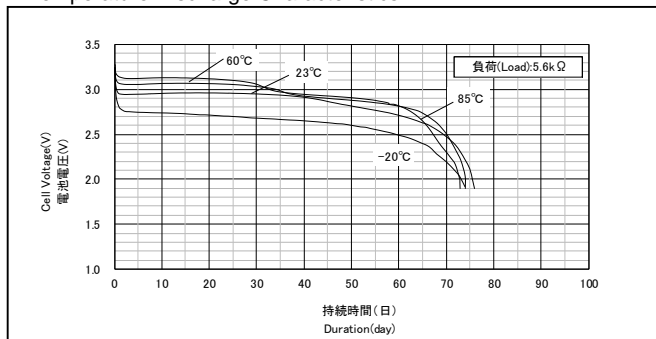

Temperature Discharge Characteristics

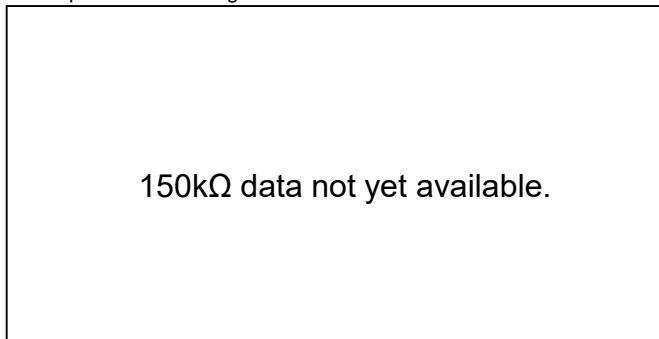

Discharge Characteristics after Storage

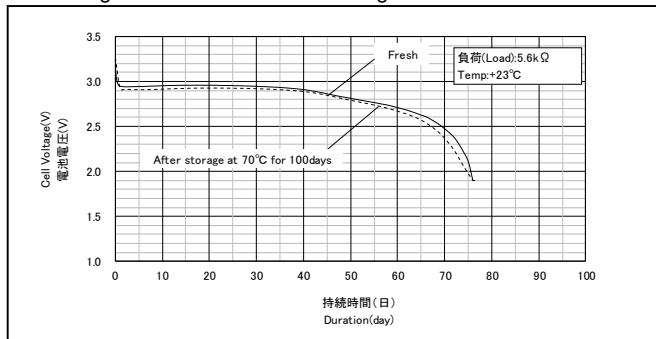

Discharge Load vs. Capacity

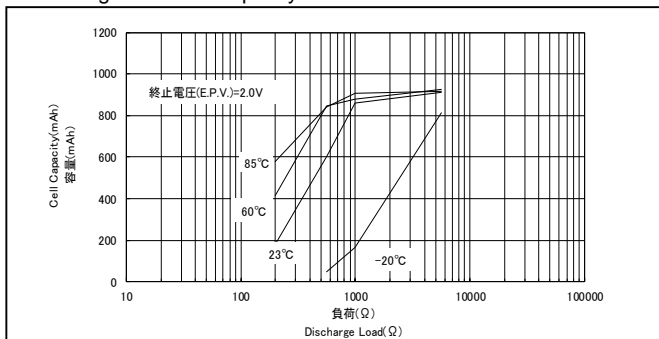

Discharge Load vs. Operating Voltage

