

Data sheet

Dimensions

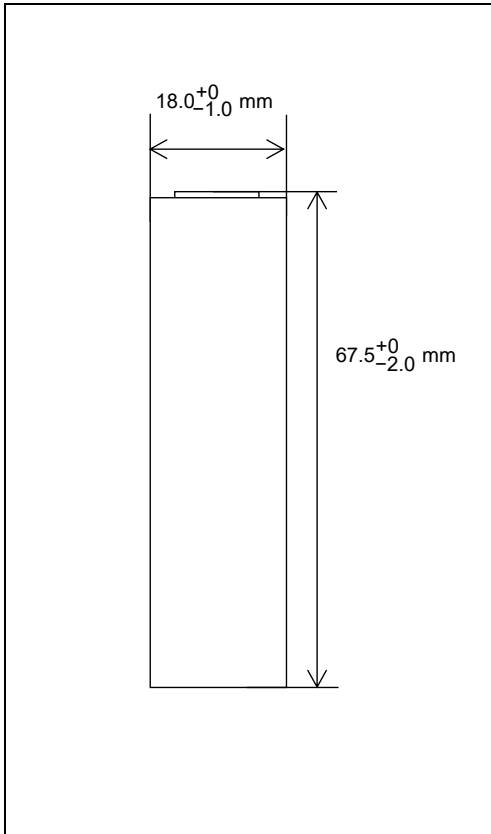

Dimensions (including tube)	Diameter	18.0 +0/ -1.0 mm
	Height	67.5 +0/ -2.0 mm
Approx. Weight (including tube)		59 g
Approx. Internal Impedance at 1kHz 20°C ₅₎		20 mΩ

5) After 3 cycles of charge and discharge under the conditions of 1), followed by the measurement 1~4 hours later.

Capacity

Nominal ₁₎	4500 mAh
Minimum ₁₎	4100 mAh

1)Single cell capacity under the following condition.

Charge : 410 mA x 16 hours, Discharge : 820 mA(E.V.=1.00 V) at 20 °C

General Specifications

Nominal Voltage		1.2 V
End Voltage		1.00 V
Charging Current x Time		Fast Charge ₂₎ 3000 mA x about 1.6 hours
Ambient Temp.	Charge Condition ₃₎	Fast Charge ₂₎ 0 °C ~ +40 °C
	Discharge Condition ₃₎	Recommended 0 °C ~ +50 °C
Relative Humidity ₄₎		45 % ~ 85 %

2)Use recommended charging system.

3)Charge or discharge on outside the recommended temperature range may generate the battery degradation.

4)No water condensation.

Storage Conditions

Ambient Temp.	Less than 30 days	-20 °C ~ +50 °C
	Less than 90 days	-20 °C ~ +40 °C
	Less than 1 year	-20 °C ~ +30 °C
Relative Humidity ₆₎		45 % ~ 85 %

6)No water condensation.

Nominal Charge Characteristics

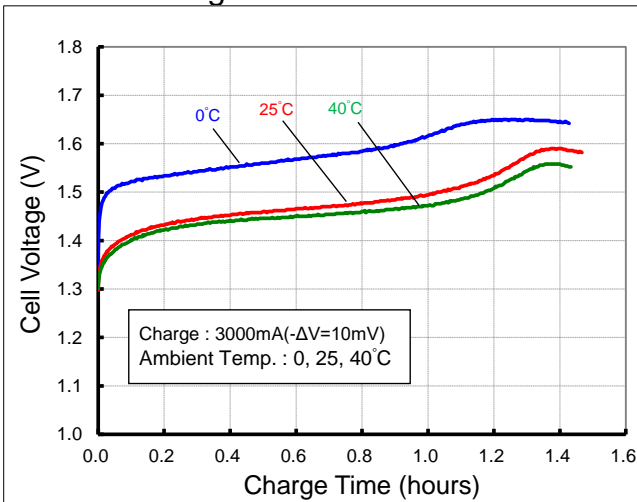

Nominal Discharge Characteristics

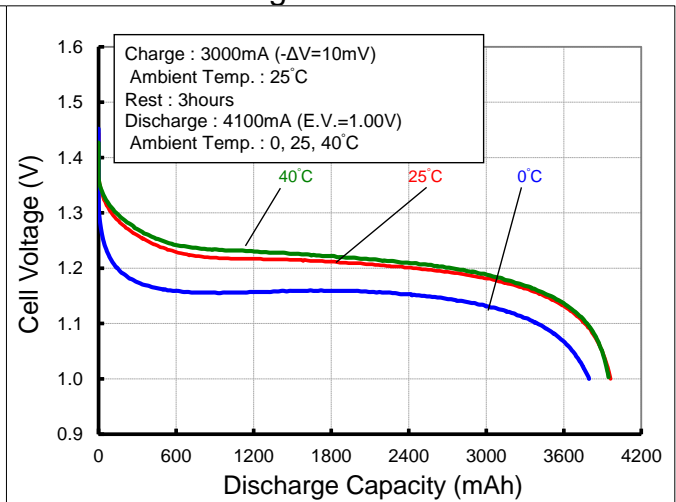

- Single cell performance and lifespan are greatly affected by usage and temperature conditions.
- Test results vary depending on individual cells.
- Each values included in this material are intended to describe performance. They are not guaranteed.